

INSTALLATION INSTRUCTIONS

Receiver: R17-01

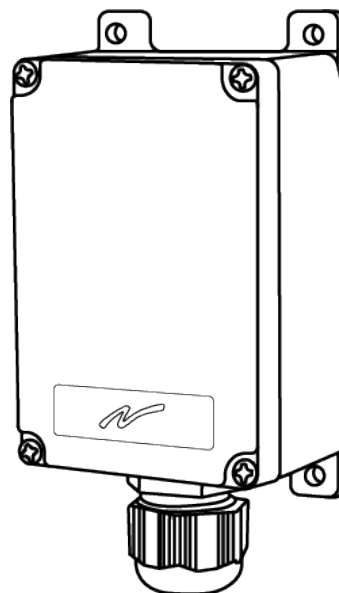
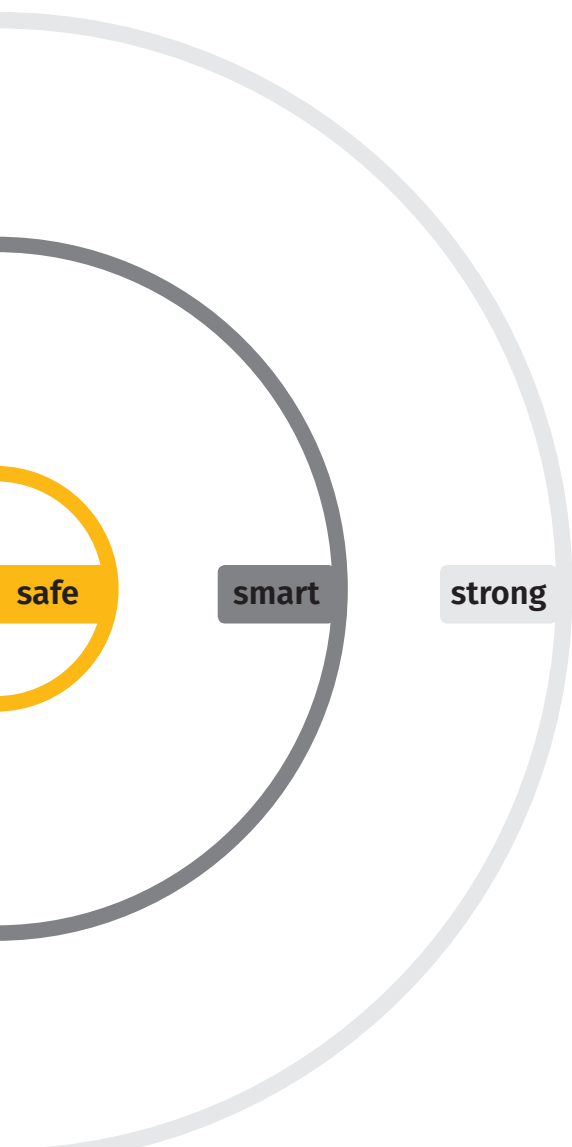

IMPORTANT! This document is intended for R17 receivers with software version SW0014-21v08 or higher.

For receivers with software version SW0014-21v07 or lower, please refer to the installation instructions IM-PN-RX104-A04-EN.

©Tele Radio AB

Datavägen 21

SE-436 32 Askim

Sweden

Phone: +46 (0)31 748 54 60

CONTENTS

CHAPTER 1: INTRODUCTION	5
1.1 About this document	6
1.2 About R17 receiver	7
CHAPTER 2: SAFETY	8
2.1 Warnings & restrictions	8
CHAPTER 3: TECHNICAL DATA	12
3.1 Receiver specifications	12
3.2 Current consumption	12
CHAPTER 4: PRODUCT GENERAL DESCRIPTION	13
4.1 Receiver description	13
4.2 Mechanical installation	14
CHAPTER 5: BOARD DESCRIPTION	16
5.1 Base board	16
CHAPTER 6: STATUS AND ERROR INDICATIONS	19
6.1 Function LEDs indication in normal operation	19
6.2 Status LEDs indications in operation mode	21
6.3 Menu mode indications	21
6.4 Debug mode indications	22
6.5 Error indications and code messages	23
CHAPTER 7: OPERATION	24
7.1 General information	24
7.2 Radio mode	24
7.3 Login/logout function	24
CHAPTER 8: CONFIGURATION MENU	25
8.1 Menu mode	25
8.2 Register the transmitter in the receiver	26
8.3 Show settings	27
8.4 Operating modes	28
8.5 Active Load select	32
8.6 Log a transmitter out	34
8.7 Erase all registered transmitters	35
8.8 Master reset of the receiver	36

CHAPTER 9: WARRANTY, SERVICE, REPAIRS, AND MAINTENANCE	37
CHAPTER 10: REGULATORY INFORMATION	38
10.1 Europe	38
ANNEX A: INDEX	39

CHAPTER 1: INTRODUCTION

Thank you for purchasing a Tele Radio AB product



READ ALL INSTRUCTIONS AND WARNINGS CAREFULLY BEFORE MOUNTING, INSTALLING, CONFIGURING AND OPERATING THE PRODUCTS.

These Installation instructions have been published by Tele Radio AB and are not subject to any warranty. The Installation instructions may be withdrawn or revised by Tele Radio AB at any time and without further notice. Corrections and updates will be added to the latest version of the manual. Always download the Installation instructions from our website, www.tele-radio.com, for the latest available version. Keep the safety instructions for future reference.

IMPORTANT! These instructions are intended for installers and authorized service and distribution centers. The instructions containing information about the installation and configuration of the radio remote control unit on the machine are NOT intended to be passed on to the end user. Only information that is needed to operate the machine correctly by radio remote control may be passed on to the end user.

Tele Radio AB remote controls are often built into wider applications. This documentation is not intended to replace the determination of suitability or reliability of the product for specific user applications and should not be used for this purpose. It is the responsibility of any such users or integrators to perform the appropriate and complete risk analysis, evaluation and testing of the products with respect to the relevant specific application or use. Tele Radio AB shall not be responsible or liable for misuse of the information contained herein.

Always refer to the applicable local regulations for installation and safety requirements relating to cranes, hoists, material handling applications, lifting equipment, industrial machinery, and/or mobile hydraulic applications using Tele Radio AB products, e.g.:

- applicable local and industrial standards and requirements,
- applicable occupational health and safety regulations,
- applicable safety rules and procedures for the factory where the equipment is being used,
- user and safety manuals or instructions of the manufacturer of the equipment where Tele Radio AB remote control systems are installed.

Tele Radio AB Installation instructions do not include or address the specific instructions and safety warnings of the end product manufacturer.

Tele Radio AB products are covered by a warranty against material, construction, or manufacturing faults. See "Chapter 9: Warranty, service, repairs, and maintenance".

1.1 About this document

Before installing or operating the product, read the corresponding documentation carefully.

Tele Radio AB's product range is composed of transmitters, receivers, and accessories intended for use together as a system.

These Installation instructions cover general safety issues, main technical specifications, standard installation, configuration and operating instructions, and general troubleshooting. Images shown in this document are for illustrative purposes only.

Please report any error or omission in this document, as well as any improvement or amendment suggestion to td@tele-radio.com.

1.1.1 COPYRIGHT

Information in this document is subject to change without notice. No part of this publication may be reproduced, stored in a retrieval system, or transmitted in any form or by any means, electronic, photographic, mechanical (including photocopying), recording or otherwise for any purpose other than the purchaser's personal use without the written permission of Tele Radio AB.

1.1.2 TERM AND SYMBOL DEFINITIONS

The capitalized terms and symbol used herein shall have the following meaning:

- **WARNING:** indicates a hazardous situation which, if not avoided, could result in death or serious injury.
- **CAUTION:** indicates a hazardous situation which, if not avoided, will result in minor or moderate injury.
- **IMPORTANT:** is used for information that requires special consideration.
- **NOTE:** is used to address practices not related to physical injury.



This symbol is used to call attention to safety messages that would be assigned the signal words "WARNING" or "CAUTION".

1.2 About R17 receiver

Tele Radio AB's remote control systems are suitable for a wide variety of applications for e.g. stationary or mobile equipments, hydraulic machines, construction, forestry or agriculture equipments and more. Tele Radio AB's transmitters and receivers are highly customizable and can be configured to suit the most wide-ranging application requirements & usage habits.

R17 receivers have simplex communication with support for duplex and can work in either discontinuous or continuous mode.

CHAPTER 2: SAFETY

2.1 Warnings & restrictions



Carefully read through the following safety instructions before proceeding with the installation, configuration, operation, or maintenance of the product. Failure to follow these warnings could result in death or serious injury.

This product must not be operated without having read and understood the Installation instructions and having received the appropriate training. The purchaser of this product has been instructed how to handle the system safely. The following information is intended for use as a complement to applicable local regulations and standards.

IMPORTANT! Tele Radio AB remote controls are often built into wider applications. These systems should be equipped with:

- a wired emergency stop where necessary
- a brake
- an audible or visual warning signal

2.1.1 INSTALLATION AND COMMISSIONING

IMPORTANT! Only licensed or qualified personnel should be permitted to install the product.



This radio system must not be used in areas where there is a risk of explosion.



Always switch off all electrical power from the equipment before installation procedure.



To utilize the safety features of the system, use the stop relays in the safety circuitry of the object/ equipment to be controlled.



When the equipment controlled by the receiver's standard relays is connected via the stop relays, make sure that the maximum current through the stop relays is still within the specifications. Contact your representative for assistance.



RISK OF UNINTENDED EQUIPMENT OPERATION

Only transmitters that are intended for use should be registered in the receiver.

Failure to follow these instructions could result in death, serious injury, or equipment damage.



RISK OF ELECTRIC SHOCK

The receiver must only be opened by qualified installers or authorized personnel.

Make sure the power supply is switched off before opening the receiver. Failure to follow these instructions could result in death, serious injury, or equipment damage.



- **The receiver must be securely attached and located where it will not be hit by e.g. any moving parts.**
- **Do not install the product in areas affected by strong vibrations**
- **Cable glands and vent plugs must face downwards to prevent water ingress.**
- **Ensure that the power supply is connected to the correct terminals.**
- **Ensure that flexible cords and cables are not damaged through friction or stress.**
- **Do not use damaged cables.**
- **Ensure cables and connectors do not hang loose.**

- The receiver is designed to withstand normal weather conditions but should be protected from extreme conditions.
- Mount the receiver in a location where the LEDs are easily visible and the buttons on the receiver accessible.
- Make sure to install available accessories inside or on the receiver before permanently installing the receiver. A permanent installation of the product

must include fuse protection of the equipment and cables against short circuits.

2.1.2 OPERATION



Only qualified personnel should be permitted to access the transmitter and operate the equipment.



- **Make sure that the user satisfies the age requirements in your country for operating the equipment.**
- **Make sure that the user is not under the influence of drugs, alcohol and medications.**
- **Make sure that the user knows and follows operating and maintenance instructions as well as all applicable safety procedures and requirements.**

The user should:



- **Always test the transmitter stop button before operating it. This test should be done on each shift, without a load.**
- **Never use a transmitter if the stop button is mechanically damaged. Contact your supervisor or representative for service immediately.**
- **Never leave the transmitter unattended.**
- **Always switch the transmitter off when not in use. Store in a safe place.**
- **Keep a clear view of the work area at all times.**

2.1.3 MAINTENANCE



Before maintenance intervention on any remote controlled equipments:

- **always remove all electrical power from the equipment.**
 - **always follow lockout procedures.**
-
- Keep the safety information for future reference. Always download the Installation instructions from our website, www.tele-radio.com, for the latest available version.
 - If error messages are shown, it is very important to find out what caused them. Contact your representative for help.

- The functionality of the stop button should be tested at least after every 200 hours' use.
- If the stop button is mechanically damaged, do not use the transmitter. Contact your supervisor or representative for service immediately.
- Keep contacts and antennas clean.
- Wipe off dust using a clean, slightly damp cloth.
- Never use cleaning solutions.
- Check the encapsulation, foils and cable for damages. If the encapsulation or foil is damaged, moisture can cause serious damage to the electronics.

CHAPTER 3: TECHNICAL DATA

3.1 Receiver specifications

Input power	7–32 V DC
Frequency band	2405–2480 MHz
Number of channels	16 (channel 11–26)
Radio communication	Simplex
Max. number of registered transmitters	8
Number of transistor outputs*	4
Number of digital inputs	8
IP code	IP65
Dimensions	96 x 54 x 38 mm / 3.8 x 2 x 1.5 in
Weight	Max. 200 g / 0.44 lbs
Operating temperature	-20...+55 °C / -4...+130 °F
Antenna	Internal antenna

* Maximum continuous current for a transistor is 3 A. Maximum intermittent current for a transistor is 10 A (at 25 °C).

3.2 Current consumption

Input power	Typical*
12 V DC	40 mA
24 V DC	40 mA

*Receiver powered, no loads added.

CHAPTER 4: PRODUCT GENERAL DESCRIPTION

The pictures shown in this chapter are for illustrative purposes only.

4.1 Receiver description

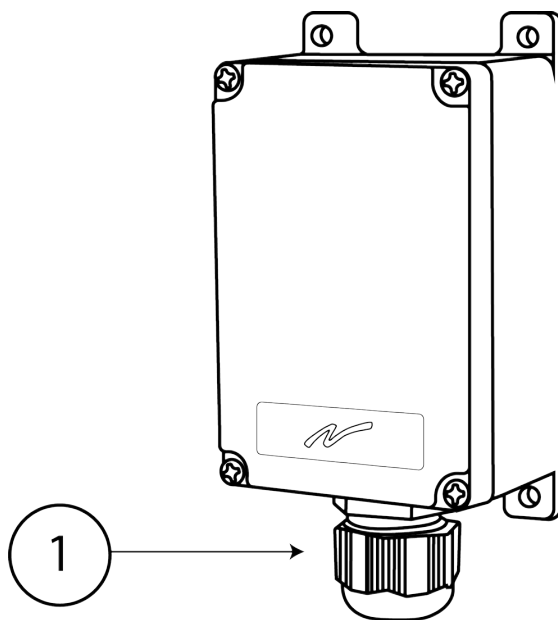

1. Power cable gland (M12x1.5)

4.2 Mechanical installation

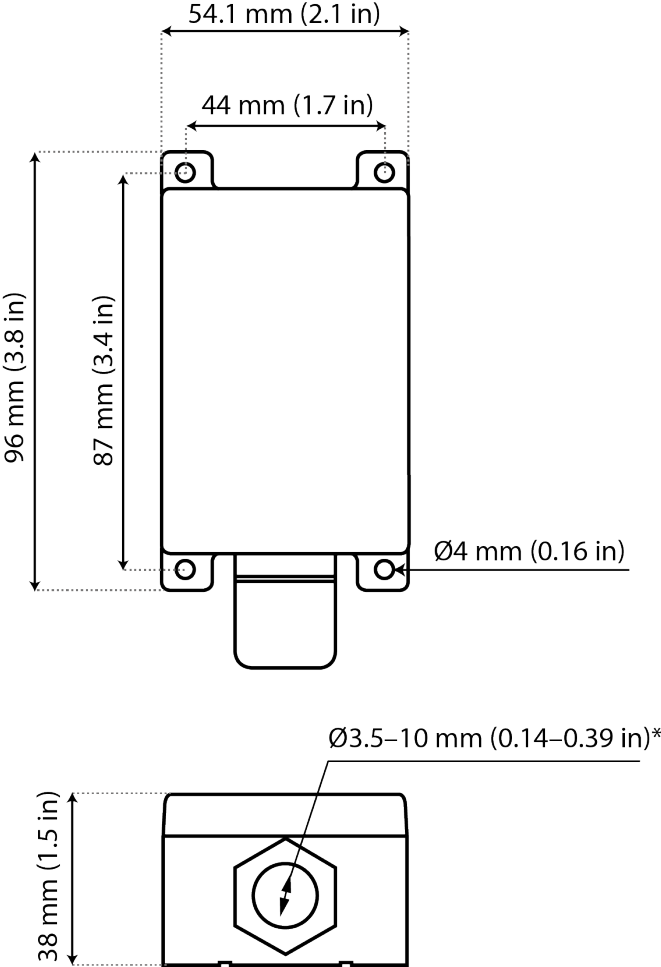

4.2.1 INSTALLATION PRECAUTIONS

RISK OF ELECTRIC SHOCK



The receiver must only be opened by qualified installers or authorized personnel.

Make sure the power supply is switched off before opening the receiver. Failure to follow these instructions could result in death, serious injury, or equipment damage.

IMPORTANT! Only authorized personnel should install the product.

Only correct installation complies with the safety levels for the product.

- A permanent installation of the receiver must include fuses in order to protect the equipment and cables from short circuit.
- The receiver must be installed vertically, on a flat and rigid surface, with the cable at the bottom.
- Install the receiver in a location where it is easily visible.
- Consider the wiring limitation and the radio communication limitation to choose the receiver location.
- Ensure no obstacle is impairing the radio communication performance between the receiver and the transmitter.
- The receiver must not be installed inside closed metal containers.
- Make sure any accessories inside or on the receiver are installed before permanently installing the receiver.
- Test the equipment before installing the receiver permanently.

CHAPTER 5: BOARD DESCRIPTION

NOTE: The pictures shown in this chapter are for illustrative purposes only.

RISK OF ELECTRIC SHOCK

The receiver must only be opened by qualified installers or authorized personnel.



Make sure the power supply is switched off before opening the receiver. Failure to follow these instructions could result in death, serious injury, or equipment damage.

IMPORTANT! Only experienced electronic technicians should add and map expansion boards and inputs/outputs.

5.1 Base board

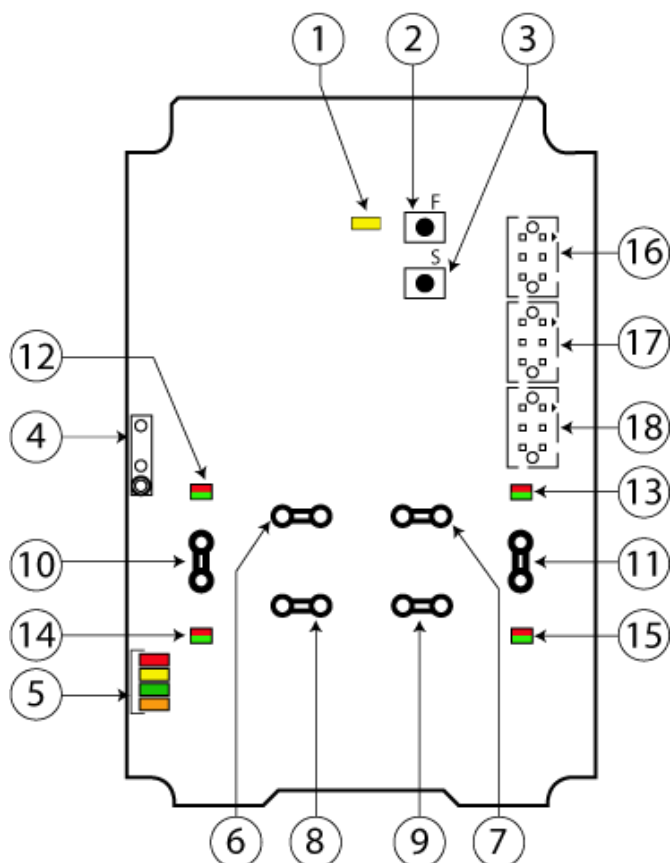

- | | |
|---|---|
| 1. Power LED (yellow) | 10. Input power GND* |
| 2. Function button (cancel) | 11. Input power 12–24 V DC* |
| 3. Select button (OK) | 12. Status LED 1, for transistor output 1 |
| 4. Programming contact | 13. Status LED 2, for transistor output 2 |
| 5. Function LEDs
(5 = red, 6 = yellow, 7 = green,
8 = orange) | 14. Status LED 3, for transistor output 3 |
| 6. Transistor output 1* | 15. Status LED 4 for transistor output 4 |
| 7. Transistor output 2* | 16. J11. Connector for DI** |
| 8. Transistor output 3* | 17. J9. Connector for DI** |
| 9. Transistor output 4* | 18. J8. Connector for DI** |

* Blade terminal (4.8 mm, male)

** For applications requiring **Operating modes** other than 1 or 2.

5.1.1 TERMINAL BLOCKS J11 – J8

NOTE: J11– J8 connectors are deactivated by default. Contact your representative for assistance.

Terminal block for digital inputs on the base board – J11

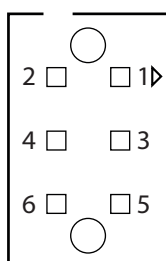

1. GND
2. Function button
3. Digital input 8
4. Select button
5. Digital input 7
6. Not used

Terminal block for digital inputs on the base board – J9

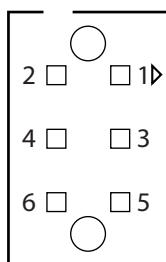

1. Digital input 6
2. Not used
3. Digital input 5
4. Not used
5. Digital input 1
6. GND

Terminal block for digital inputs on the base board – J8

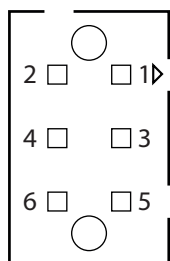

1. Digital input 2
2. +3.3 V DC
3. Digital input 3
4. Supply voltage
5. Digital input 4
6. GND

CHAPTER 6: STATUS AND ERROR INDICATIONS

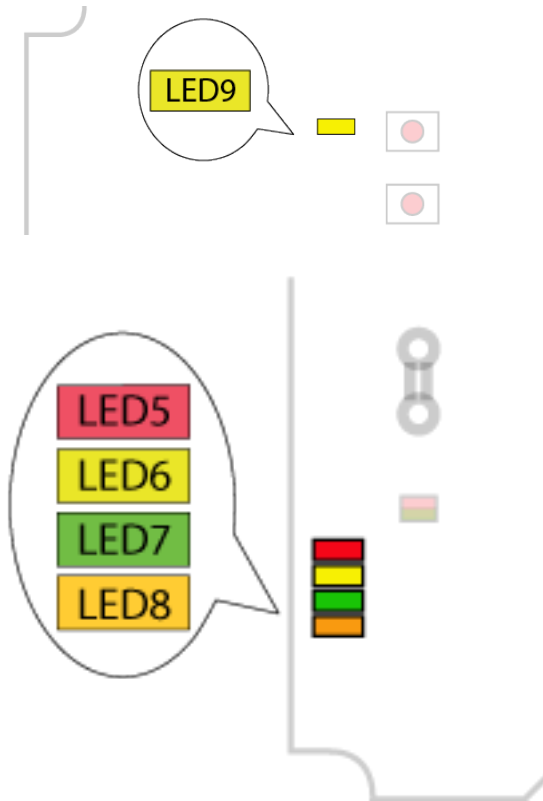

6.1 Function LEDs indication in normal operation

LED (s)	Color	Off	On	Flashing	Indicates
9	yellow	○			No power to the receiver
			●		Receiver is powered up
5	red	○			No transmitter is registered.
			●	Single flash	One or more transmitters are registered.. No radio link.
			●	Double flash	One or more transmitters are registered and logged in. No radio link.
			●	Solid	Radio link established.
6	yellow		●		Receiving a radio packet from a transmitter other than a Panther.

LED (s)	Color	Off	On	Flashing	Indicates
6 7	yellow green		● ●		Receiving a radio packet from a transmitter set to a different radio mode (discontinuous or continuous) than the receiver.
6 8	yellow orange		● ●		Receiving a radio packet from a transmitter that is not registered.
7	green		●		Receiving a radio packet, low signal (RSSI).
8	orange		●		Receiving a radio packet, configuration ID not accepted.
7 8	green orange		● ●		Receiving a radio packet, custom ID not accepted.
6 7 8	yellow green orange		● ● ●		<p>1. Receiving a radio packet from a registered transmitter. The receiver is already controlled by another registered transmitter.</p> <div style="border: 1px solid black; padding: 5px; margin: 5px 0;"> <p>NOTE: "Radio link" must be activated in the receiver.</p> </div> <p>2. Load select mode is activated. . Incorrect Load is selected on the transmitter.</p>
5 6 7 8	red yellow green orange		● ● ● ●		TRABUS mode activated (PC communication).

6.2 Status LEDs indications in operation mode

There are four 2-color status LEDs (red/green) for status indication of the transistor outputs.

Status LEDs	Color	Off	On	Flickering	Indicates
1-4	-	○			Transistor output High impedance
	red		●		Transistor output High
	green		●		Transistor output Low
	red/green alternately			●	Transistor output(s) have switched off due to shortcut or overcurrent

6.3 Menu mode indications

The different menus are identified by the Function LEDs 5-8 according to the following table.

●: LED is lit. ○: LED is off.

Function LEDs				Menu
LED 5 (red)	LED 6 (yellow)	LED 7 (green)	LED 8 (orange)	
●	○	○	○	Register/ erase transmitters
○	●	○	○	Not used
○	○	●	○	Show settings
○	○	○	●	Show/ change Operating mode
○	○	●	●	Active Load select (extended menu)

6.4 Debug mode indications

If the debug mode is activated, function LEDs will get new functions according to the following table:

NOTE: Only use this setting for debug purpose.

Function LEDs	Color	Indication	Off	On	Description
LED5	red	Valid packet received	○	●	LED is inverted every time a valid packet is received
LED6	yellow	No button timeout		●	Timeout not reached
			○		Timeout reached, zero button information is added to the receiver.
LED7	green	Radio link		●	Radio transmission established.
			○		No radio transmission established.
LED 5	orange	Not used			

6.5 Error indications and code messages

Errors are indicated by function LEDs 5–8, which are all flashing at the same time.

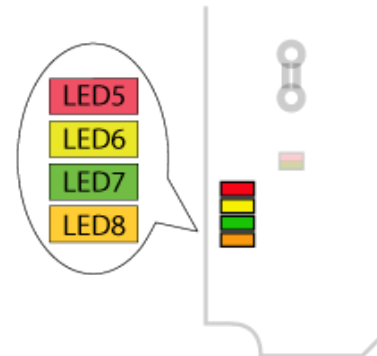

Each error is identified by a code indicated by status LEDs 1–4.



Write down which status LEDs are lit and contact your representative for assistance.

●: LED is lit. ○: LED is off.

Status LED1 red	Status LED2 red	Status LED3 red	Status LED4 red	Indicates
○	○	○	●	Reading of production data failed
○	○	●	○	Radio module start-up failed
○	○	●	●	Function block error
○	●	○	○	Invalid operating mode selected
○	●	○	●	Receiver not locked on channel 11 when using batteryless button (BLB)

CHAPTER 7: OPERATION

7.1 General information

To control a receiver, the transmitter must be registered and logged in to the receiver. If another transmitter is already logged in to the receiver, it must be logged out before a different transmitter can be logged in.

More than one transmitter can be registered in the receiver, but only one transmitter can be logged in at a time.

NOTE: If more than one transmitter is registered in the same receiver, it is recommended to select the same frequency channel on all transmitters.

7.2 Radio mode

The radio mode is determined by the selected **Operating mode**.

To establish a radio link between the transmitter and the receiver, both units must be set to the same radio mode.

Some settings can only be selected when the products are transmitting continuously. These settings are indicated with the note "Only for continuous radio mode."

7.3 Login/logout function

NOTE: Only for **continuous** radio mode.

NOTE: The login/logout function cannot be activated/deactivated in the receiver. Contact your representative for assistance.

For this receiver, the login/logout function is deactivated by default.

Logging out means stopping the communication between the transmitter and the receiver, and freeing the receiver for another registered transmitter to log in.

CHAPTER 8: CONFIGURATION MENU

NOTE: The settings described in this chapter apply to R17 receiver with Software version **SW0014-21v08 or higher**.

All configuration settings require access to the receiver circuit board(s).

RISK OF ELECTRIC SHOCK

The receiver must only be opened by qualified installers or authorized personnel.



Make sure the power supply is switched off before opening the receiver. Failure to follow these instructions could result in death, serious injury, or equipment damage.

1. Remove the front cover of the receiver. Use a screwdriver to remove the screws.
2. Power the receiver up.
3. The power LED lights (yellow).
4. Proceed with the configuration instructions of your choice.

8.1 Menu mode

To select the different menus, press the **Function** button a predefined number of times according to the following table. Press the **Select** button to enter.

The different menus are identified by the function LEDs 5–8 (see "5.1 Base board").

●: LED is lit. ○: LED is off.

Menu	To select the menu, press the Function button...	Function LEDs light			
		LED 1 (red)	LED 2 (yellow)	LED 3 (green)	LED 4 (orange)
Register/Erase transmitters	once	●	○	○	○
Not used	2 times	○	●	○	○
Show settings	3 times	○	○	●	○
Show/Change Operating mode	4 times	○	○	○	●
Active Load select (extended menu)	5 times and keep pressed until LED3–4 light.	○	○	●	●

8.2 Register the transmitter in the receiver



RISK OF UNINTENDED EQUIPMENT OPERATION

Only transmitters that are intended for use should be registered in the receiver.

Failure to follow these instructions could result in death, serious injury, or equipment damage.



RISK OF UNINTENDED EQUIPMENT OPERATION

Do not perform this action when the receiver is in a session with another transmitter. The radio communication may be interrupted or broken.

Failure to follow these instructions could result in death, serious injury, or equipment damage.

NOTE: To establish a radio link between the transmitter and the receiver, both units must be set to the same radio mode.

1. Set the transmitter in registration mode (see relevant Tele Radio AB transmitter installation instructions).
2. Press the **Function** button.
Function LED 5 lights (red).
3. Press the **Select** button.
All status LEDs light (red).
4. Press buttons 1 and 2 on the transmitter to be registered in the receiver.¹
All function LEDs and status LEDs flash 3 times.
5. Release the transmitter buttons.
All function LEDs and status LEDs flash 1 time. The transmitter is registered.

If no transmitter is found within approximately 10 seconds, the receiver exits to normal operation.

¹Button 1 and 2 are factory defaults (see relevant Tele Radio AB transmitter installation instructions).

8.3 Show settings

1. Press the receiver **Function** button three times.

Function LED 7 lights (green).

2. Press the **Select** button.

The status LEDs 1–4 indicate the current settings according to the following table:

Status LED	Color	Off	On	Indicates
1	red	○		Discontinuous transmitting mode
			●	Continuous transmitting mode
2	red	○		Custom ID not enabled
			●	Custom ID enabled
3	red	○		Configuration ID not enabled
			●	Configuration ID enabled
4	red	○		Frequency scan on
			●	Frequency scan off (fixed frequency)

After approximately 10 seconds, the receiver will automatically exit "Show Settings" mode and return to normal operation.

8.4 Operating modes

This receiver is provided with three **Operating modes** as standard (1, 2 and 255). For other **Operating modes**, contact your representative for assistance.

NOTE: If operating mode 255 has been selected, it is not possible to change the **Operating mode** from the receiver.

8.4.1 SHOW/ CHANGE OPERATING MODE



RISK OF UNINTENDED EQUIPMENT OPERATION

Do not perform this action when the receiver is in a session with another transmitter. The radio communication may be interrupted or broken. Failure to follow these instructions could result in death, serious injury, or equipment damage.

1. Press the **Function** button four times.

*Function LED 8 lights (orange). The status LEDs indicate the current **Operating mode** according to the table below:*

status LED 1	status LED 2	status LED 3	status LED 4	Operating mode	Radio mode
●	○	○	○	1 (default)	Continuous mode
○	●	○	○	2	Continuous mode
●	●	○	○	3	Continuous mode
●	●	●	●	255	Continuous/ discontinuous depending on the settings

NOTE: If no button is pressed within approximately 10 seconds, the receiver will automatically return to normal operation.

To change **Operating mode**:

2. Press the **Select** button.
Function LED 8 flashes (orange).
3. Press the **Function** button once to move to the next available **Operating mode** (repeat until the LED combination corresponds to the desired **Operating mode**).
The corresponding status LEDs lights.
4. Press the **Select** button to confirm.
The new configuration is saved. The receiver returns to normal operation.

8.4.2 OPERATING MODE 1

NOTE: Only for **continuous** radio mode.

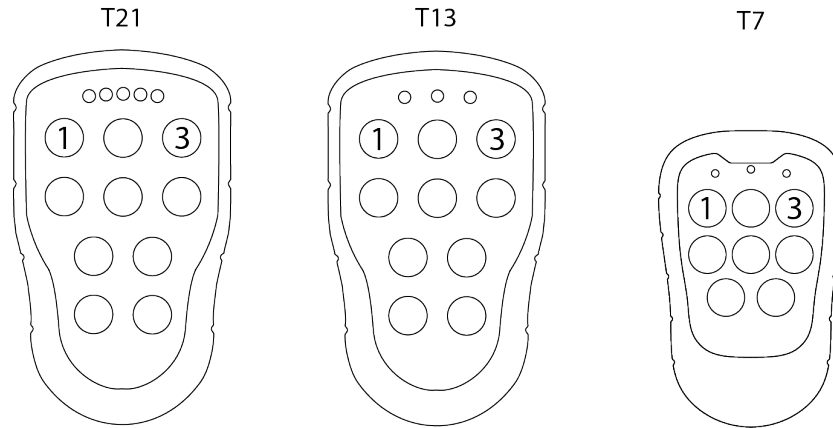

Transistor output 1	High output signal when button 1 is pressed (otherwise high impedance)
Transistor output 2	High output signal when button 3 is pressed (otherwise high impedance)
Transistor output 3	Low output signal when button 1 or 3 pressed (otherwise high impedance)
Transistor output 4	High output signal when radio transmission is established (otherwise high impedance)
Interlocking	Between buttons: 1-3
Radio mode	Continuous

8.4.3 OPERATING MODE 2

NOTE: Only for **continuous** radio mode.

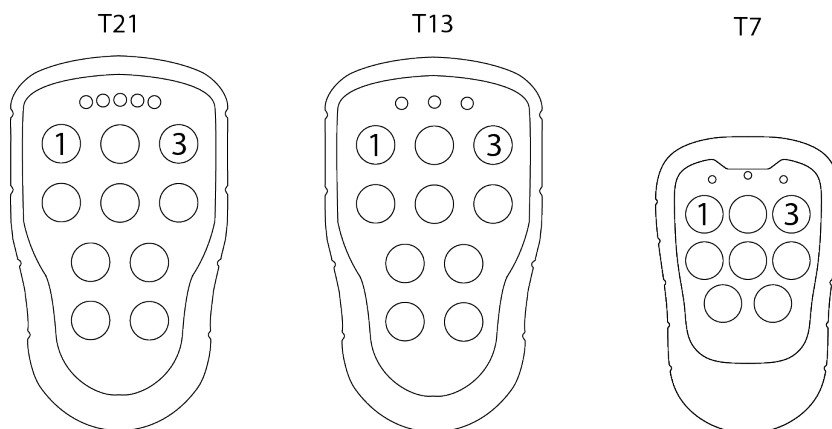

Transistor output 1	High output signal when button 1 is pressed (otherwise high impedance)
Transistor output 2	High output signal when button 3 is pressed (otherwise high impedance)
Transistor output 3	Low output signal when button 1 or 3 is pressed (otherwise high impedance)
Transistor output 4	High output signal when button 1 or 3 is pressed (otherwise high impedance)
Interlocking	Between buttons: 1- 3
Radio mode	Continuous

8.4.4 OTHER OPERATING MODES

Contact your representative for assistance.

Output pin modes

Each output can be assigned one of the following modes.

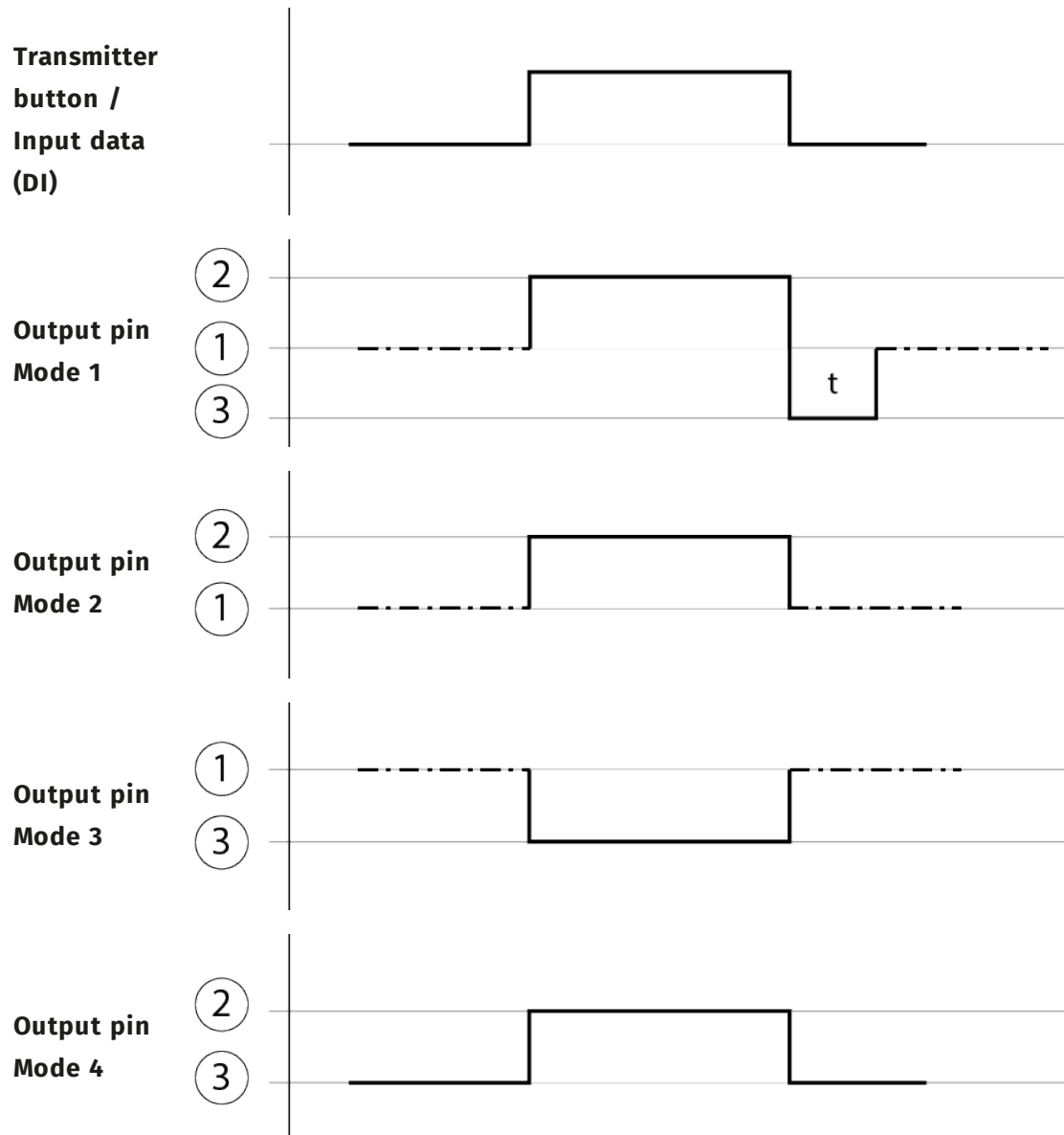

1. High impedance
2. High output signal¹
3. Low output signal

¹Depending on the input power.

8.5 Active Load select

NOTE: If this setting is set to 0 (status LEDs 1–4 are off), the receiver will always be activated when receiving a radio package. For all other settings, the receiver will be activated when the load select on the transmitter corresponds to one of the load select settings enabled in the receiver.

8.5.1 SHOW LOAD SELECT

1. Press the **Function** button five times and keep it pressed until function LEDs 8 (orange) and 7 (green) light.

*The receiver is now in extended menu mode. LEDs 5-8 show the current **Load select** setting according to the table below:*

●: LED is lit. ○: LED is off.

LED 1 (red)	LED 2 (red)	LED 3 (red)	LED 4 (red)	the receiver will be activated when...
●	○	○	○	Load A is selected on the transmitter
○	●	○	○	Load B is selected on the transmitter
○	○	●	○	Load C is selected on the transmitter
○	○	○	●	Load D is selected on the transmitter
○	○	○	○	The receiver does not listen to any load (s) and will always be activated when receiving a radio package.

NOTE: If no button is pressed within approximately 10 seconds, the receiver will automatically return to normal operation.

8.5.2 CHANGE LOAD SELECT

1. Press the **Select** button once.
LED 1 flashes. Load A can be activated.
2. Press the **Function** button to enable/ unable the Load setting.
Function LEDs 7 (green) and 8 (orange) light when a Load has been activated. They are off when no Load has been selected.
3. Press the **Select** button once to move to the next available **Load** (repeat until the LED combination corresponds to the desired **Load select**).
The corresponding status LED flashes and the Load can be activated.
4. Press the **Select** button to confirm.
The new configuration is saved.

The receiver returns to normal operation.

8.6 Log a transmitter out

NOTE: Only for **continuous** radio mode.

NOTE: The login/logout function cannot be activated/deactivated in the receiver. Contact your representative for assistance.

NOTE: This logout option should be used when a lost or damaged transmitter must be logged out from the receiver.

NOTE: If a transmitter has been lost or seriously damaged, use the replace procedure on the transmitter whenever possible.

Function LEDs 5 (red) is lit to indicate that one or more transmitter(s) are registered in the receiver and that one transmitter is logged in.

NOTE: Logout can only be performed when the transmitter is on and a radio link with one or more receivers has been established. The receiver must be powered-up for the logout procedure to be successful.

1. Press and hold the **Select** button for approx. 4 seconds or until function LED 8 goes off.
2. Release the **Select** button.
All function LEDs light briefly.

The logged in transmitter has been logged out. The receiver returns to normal operation. Any registered transmitter can now log in.

8.7 Erase all registered transmitters

NOTE: The following instructions will erase all registered transmitters from the receiver.

NOTE: An erased transmitter cannot be logged in to the receiver until it has been registered in the receiver again.

1. Press the **Function** button once.
Function LED 5 lights (red).
2. Press and hold the **Select** button for approx. 4 s or until status LEDs 1–4 go off.
All registered transmitters have been erased.

The receiver returns to normal operation.

8.8 Master reset of the receiver

This procedure will erase all settings from the receiver and restore factory defaults.

NOTE: The erase function cannot be activated/deactivated in the receiver. Contact your representative for assistance.



RISK OF UNINTENDED EQUIPMENT OPERATION

Do not perform this action when the receiver is in a session with another transmitter. The radio communication may be interrupted or broken.

Failure to follow these instructions could result in death, serious injury, or equipment damage.

1. Press both the **Select** and the **Function** buttons for approx. 10 seconds or until all function LEDs go off.
2. Release both buttons.
All status and function LEDs light briefly. The receiver has been reset.

The receiver returns to normal operation.

CHAPTER 9: WARRANTY, SERVICE, REPAIRS, AND MAINTENANCE

Tele Radio AB products are covered by a warranty against material, construction and manufacturing faults. During the warranty period, Tele Radio AB may replace the product or faulty parts. Work under warranty must be performed by Tele Radio AB or by an authorized service center specified by Tele Radio AB.

The following are **not** covered by the warranty:

- Faults resulting from normal wear and tear
- Parts of a consumable nature
- Products that have been subject to unauthorized modifications
- Faults resulting from incorrect installation and use
- Damp and water damage

Maintenance

Repairs and maintenance must be performed by qualified personnel

Only use spare parts from Tele Radio AB

Contact your representative for service or any other assistance

Keep the product in a clean, dry place

Keep contacts and antennas clean

Wipe off dust using a slightly damp, clean cloth

NOTE: Never use cleaning solutions or high-pressure washer.

CHAPTER 10: REGULATORY INFORMATION

NOTE: Models including additional naming conventions:

Model	Article names	Additional naming conventions
R17	R17-01	R00017-01, R17-1, PN-R17-1, PN-R17-01

10.1 Europe

Applies to:

R17-01

10.1.1 CE MARKING

Hereby, Tele Radio AB, declares that the radio equipment type(s) listed above is/ are in compliance with the Radio Equipment Directive 2014/53/EU.

The latest version of the complete EU Declaration of Conformity is available on the Tele Radio AB website, www.tele-radio.com.

10.1.2 WEEE DIRECTIVE



This symbol means that inoperative electrical and electronic products must not be mixed with household waste. The European Union has implemented a collection and recycling system for which producers are responsible. For proper treatment, recovery and recycling, please take this product to a designated collection point.

Tele Radio AB strives to minimize the use of hazardous materials, promotes reuse and recycling, and reduces emissions to air, soil and water. When a commercially viable alternative is available, Tele Radio AB strives to restrict or eliminate substances and materials that pose an environmental, health or safety risk.

ANNEX A: INDEX

A

Active Load select 32

B

Base board 16

Boards 16

C

code messages 23

Configuration menu 25

 Enter menu mode 25

Current consumption 12

D

Debug mode indications 22

Digital inputs on the base board 17-18

E

Erase all registered transmitters 35

Error indications 23

F

Function LEDs in normal operation mode 19

I

Input power 12

Installation precautions 15

L

Log a transmitter out 34

Login/Logout 24

Login/Logout function 24

Logout 34

M

Maintenance 37

Master reset 36

Menu mode

 Enter menu mode 25

 Menu mode indications 21

Mounting dimensions

 Receiver 14

N

Number of digital inputs 12

Number of transistor outputs 12

O

Operating modes 28

Operating temperature 12

Output pin modes 31

R

Radio communication 12

Radio mode 24

Register 26

S

Show settings 27

Show/ change Operating mode 28

Specifications 12

Status and error indications 19

Status LEDs indications 21

W

Warnings & restrictions	8
Installation and commission	8
Maintenance	10
Operation	10
WEEE directive	38

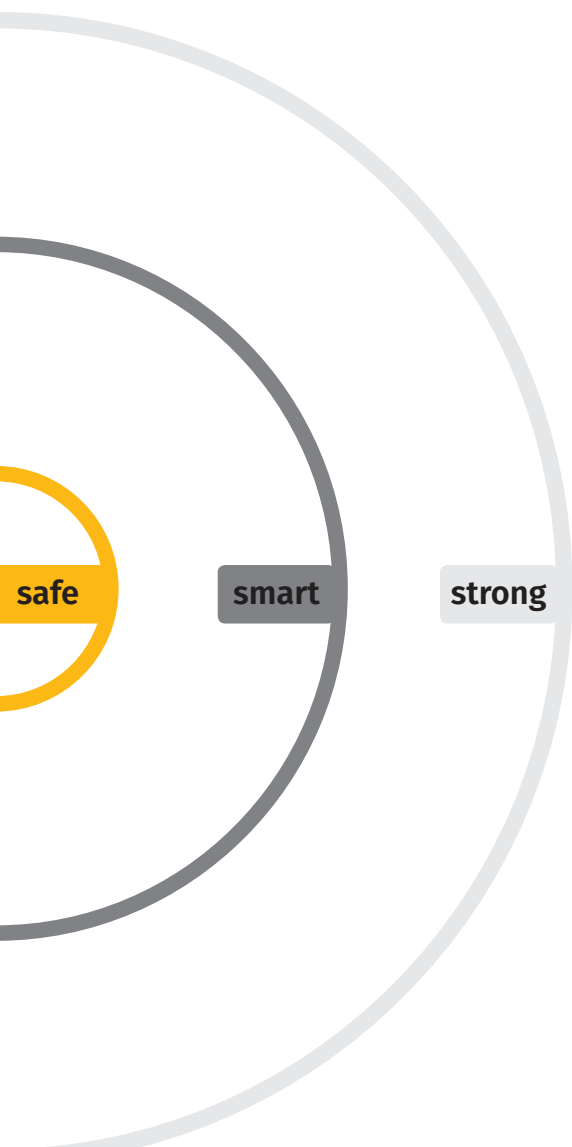

 **tele radio**[®]
wireless solutions

These Installation instructions are subject to change without prior notice.

Download the latest Installation instructions from www.tele-radio.com.